

# Elite Precast Concrete

## Vee™ interlocking blocks sheet 1

### Vee B1-610

610mm x 610mm x 610mm  
533kg  
Artic Full Load 48 no.  
Crane Offload 32 no.

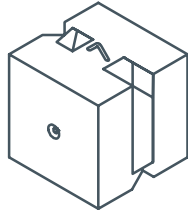

### Vee B1-915

915mm x 610mm x 610mm  
800kg  
Artic Full Load 32 no.  
Crane Offload : 22 no.

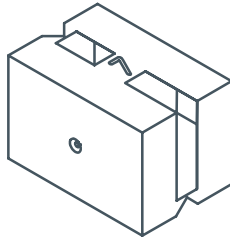

### Vee B1-1220

1220mm x 610mm x 610mm  
1067kg  
Artic Full Load 24 no.  
Crane Offload 16 no.

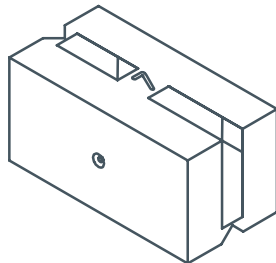

### Vee B1-1525

1525mm x 610mm x 610mm  
1333kg  
Artic Full Load 18 no.  
Crane Offload 13 no.

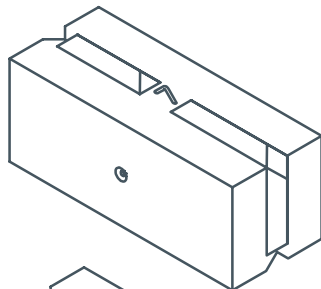

### Vee B1-1830

1830mm x 610mm x 610mm  
1600kg  
Artic Full Load 16 no.  
Crane Offload 11 no.

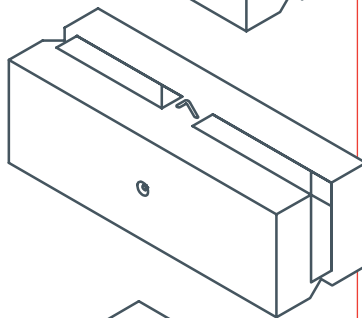

### Vee B2-610

610mm x 610 mm x 610mm  
533kg  
Artic Full Load 48 no.  
Crane Offload 32 no.

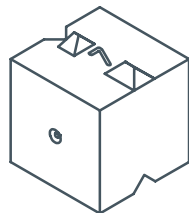

### Vee B2-915

915mm x 610mm x 610mm  
800kg  
Artic Full Load 32 no.  
Crane Offload 22 no.

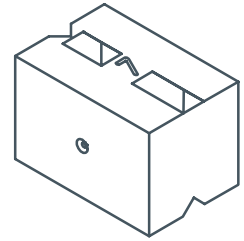

### Vee B2-1220

1220mm x 610mm x 610mm  
1067kg  
Artic Full Load 24 no.  
Crane Offload 16 no.

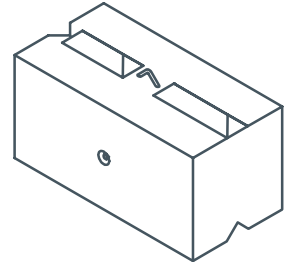

### Vee B2-1525

1525mm x 610 mm x 610mm  
1333kg  
Artic Full Load 18 no.  
Crane Offload 13 no.

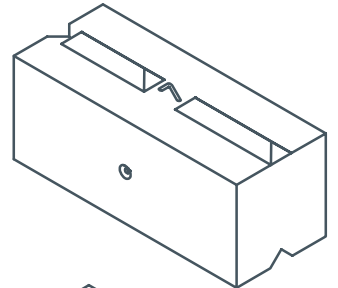

### Vee B2-1830

1830mm x 610mm x 610mm  
1600kg  
Artic Full Load 16 no.  
Crane Offload 11 no.

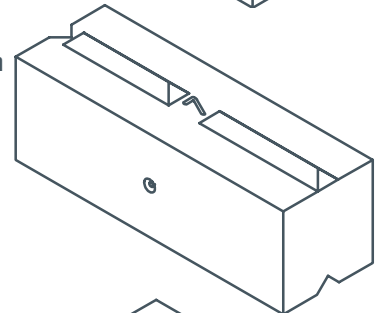

### Vee FB-610

610mm x 610mm x 610mm  
533kg  
Artic Full Load 48 no.  
Crane Offload 32 no.

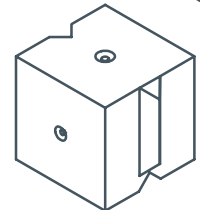

### Vee FB-915

915mm x 610mm x 610mm  
800kg  
Artic Full Load 32 no.  
Crane Offload 22 no.

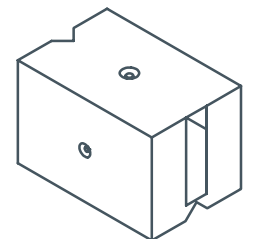

**ELITE**  
PRECAST CONCRETE

For more information or technical advice, contact 01952 588885  
or browse our products on [www.eliteprecast.co.uk](http://www.eliteprecast.co.uk)

# Elite Precast Concrete

## Vee™ interlocking blocks sheet 2

### Vee FB-1220

1220mm x 610mm x 610mm  
1067kg  
Artic Full Load 24 no.  
Crane Offload 16 no.

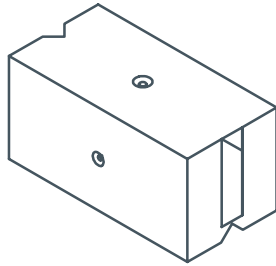

### Vee FB-1525

1525mm x 610mm x 610mm  
1333kg  
Artic Full Load 18 no.  
Crane Offload 13 no.

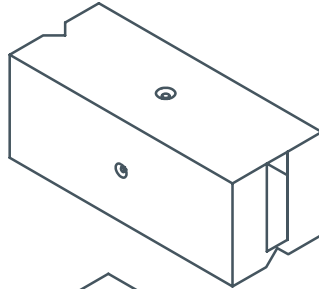

### Vee FB-1830

1830mm x 610mm x 610mm  
1600kg  
Artic Full Load 16 no.  
Crane Offload 11 no.

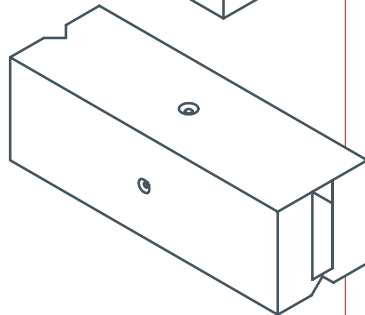

### Vee HB-610

610mm x 610mm x 305mm  
266kg  
Artic Full Load 96 no.  
Crane Offload 64 no.

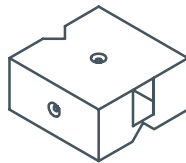

### Vee HB-915

915mm x 610mm x 305mm  
400kg  
Artic Full Load 64 no.  
Crane Offload 44 no.

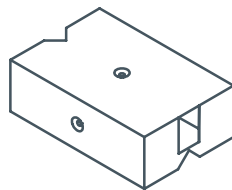

### Vee HB-1220

1220mm x 610mm x 305mm  
533kg  
Artic Full Load 48 no.  
Crane Offload 32 no.

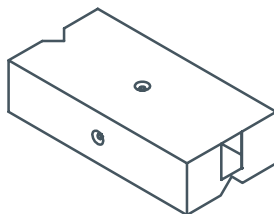

### Vee HB-1525

1525mm x 610mm x 305mm  
666kg  
Artic Full Load 36 no.  
Crane Offload 26 no.

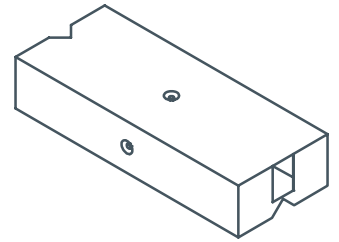

### Vee HB-1830

1830mm x 610mm x 305mm  
800kg  
Artic Full Load 32 no.  
Crane Offload 22 no.

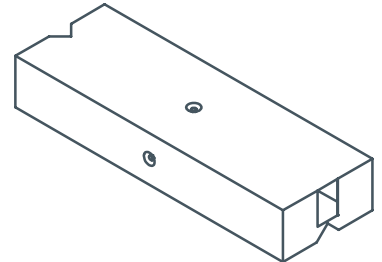

### Vee C1-1525

1525mm x 610mm x 610mm  
1333kg  
Artic Full Load 18 no.  
Crane Offload 13 no.

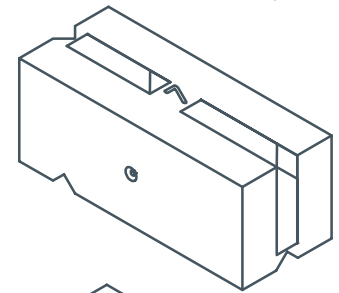

### Vee C2-1525

1525mm x 610mm x 610mm  
1333kg  
Artic Full Load 18 no.  
Crane Offload 13 no.

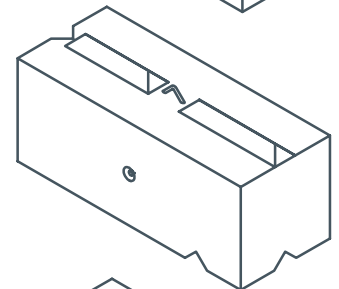

### Vee T2-1525

1525mm x 610mm x 610mm  
1333kg  
Artic Full Load 18 no.  
Crane Offload 13 no.

