

1. Handling

• Unit Volume / Weight

Unit Ref : BL2F
 Volume : 0.316 m³
 Weight : 750 kg

• Weight is based on 2,350 kg/m³

• Lifting system is by means of a 170mm long spherical pin anchor rated at 2.5 tonnes with a safety factor of 3.

• Lifting is achieved by use of a 2.5t rated pin anchor ring clutch or combination ring clutch only and should comply with the Lifting Operation & Lifting Equipment Regulations 1998 (LOLER).

• Lifting Pin Characteristics

Anchor Type : T-025-0170
 Anchor Length : 170mm
 dia : 14mm
 Foot dia : 35mm
 Load Class : 2.5 tonnes

IMPORTANT NOTE :

Prior to lifting older / pre-used blocks, check the lifting pin for wear / corrosion and check the block for cracks. If the block is cracked or the pin is worn, it could fail when lifting.

2. Concrete

- Characteristic 28 day cube strength = 50 N/mm² min.
- Concrete is Class A1 Fire Resistant in accordance with clause 4.3.4.4 of EN 13369

3. Manufacture

- Manufactured to : BS EN 13369 : 2013
- Tolerances to : BS EN 13670 : 2009

4. Physical & Chemical Properties

- Appearance : Grey in Colour
- Other Chemical Properties : Not Applicable

5. Design

- Design Life : >100 years

6. Manufacture Tolerances

- Length ±5mm
- Width ±5mm
- Height ±5mm

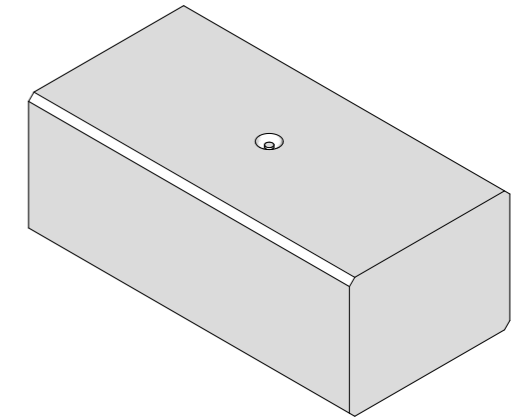
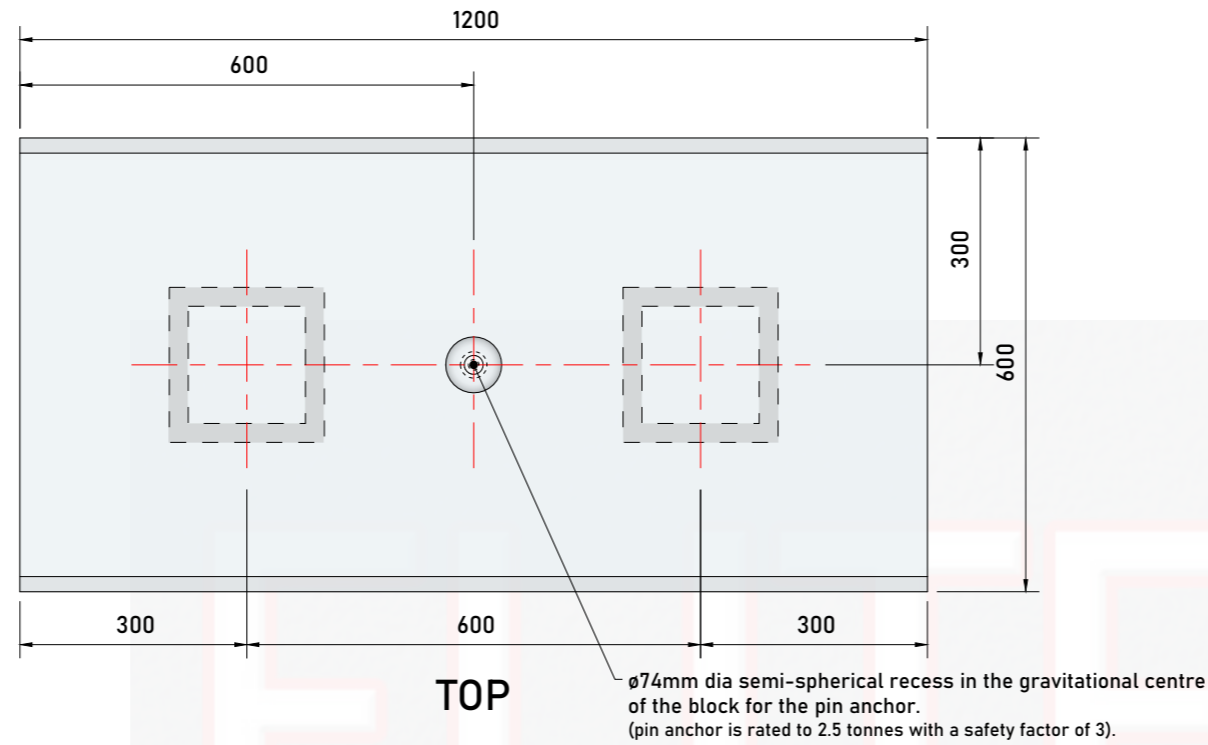

Isometric View

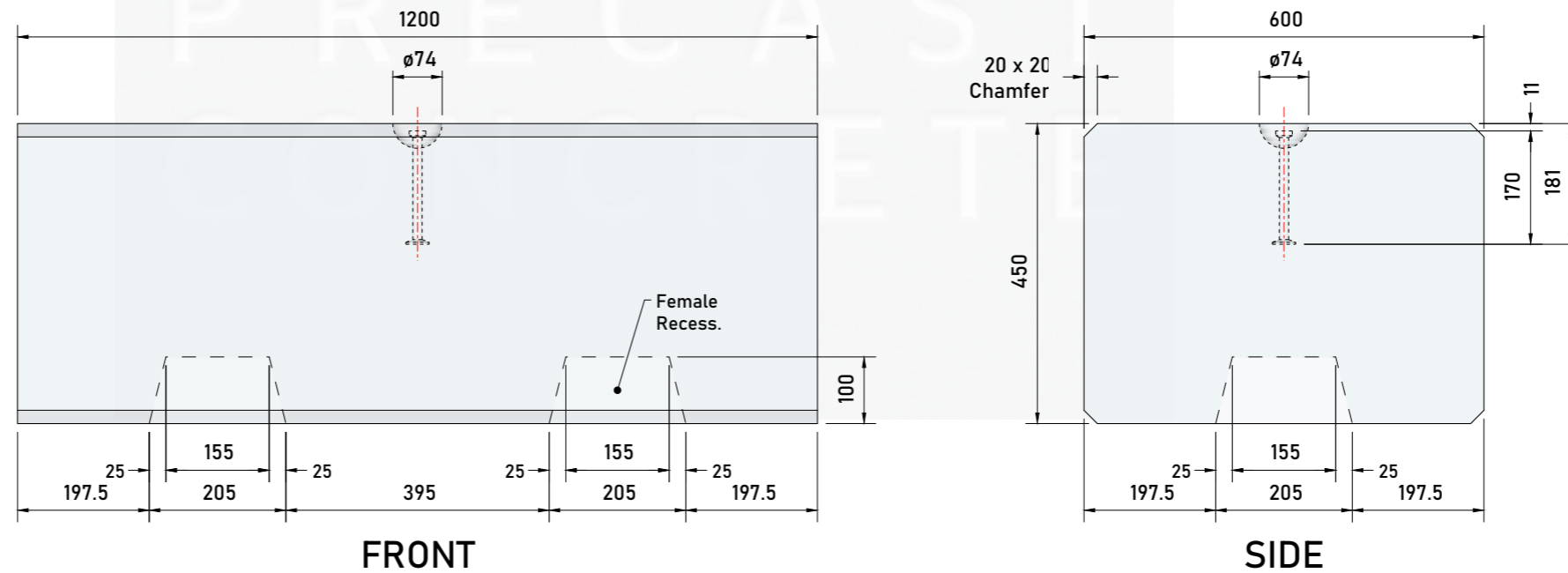

										TITLE Duo™ Interlocking Concrete Block 1200mm x 600mm x 450mm (Female Interlocks) Elite Product Code : BL2F				ELITE PRECAST CONCRETE LTD HALESFIELD 9, TELFORD SHROPSHIRE TF7 4QW www.eliteprecast.co.uk											
REV	DATE	REASON FOR ISSUE	DRN	APP	REV	DATE	REASON FOR ISSUE	DRN	APP			DRN	CTC	CHKD	RMD	DATE	23-06-16	SIZE	A3	SCALE	1:10	DRG	EPC-DUO-005	REV	B
					B	18.01.23	Title block & notes updated.	CTC	RMD																
					A	03.01.18	Drawing revised & updated.	CTC	RMD																
					O	23.06.16	For information.	CTC	RMD																