

Half Block 1 - Cobblestone - Product Code RRC7-C

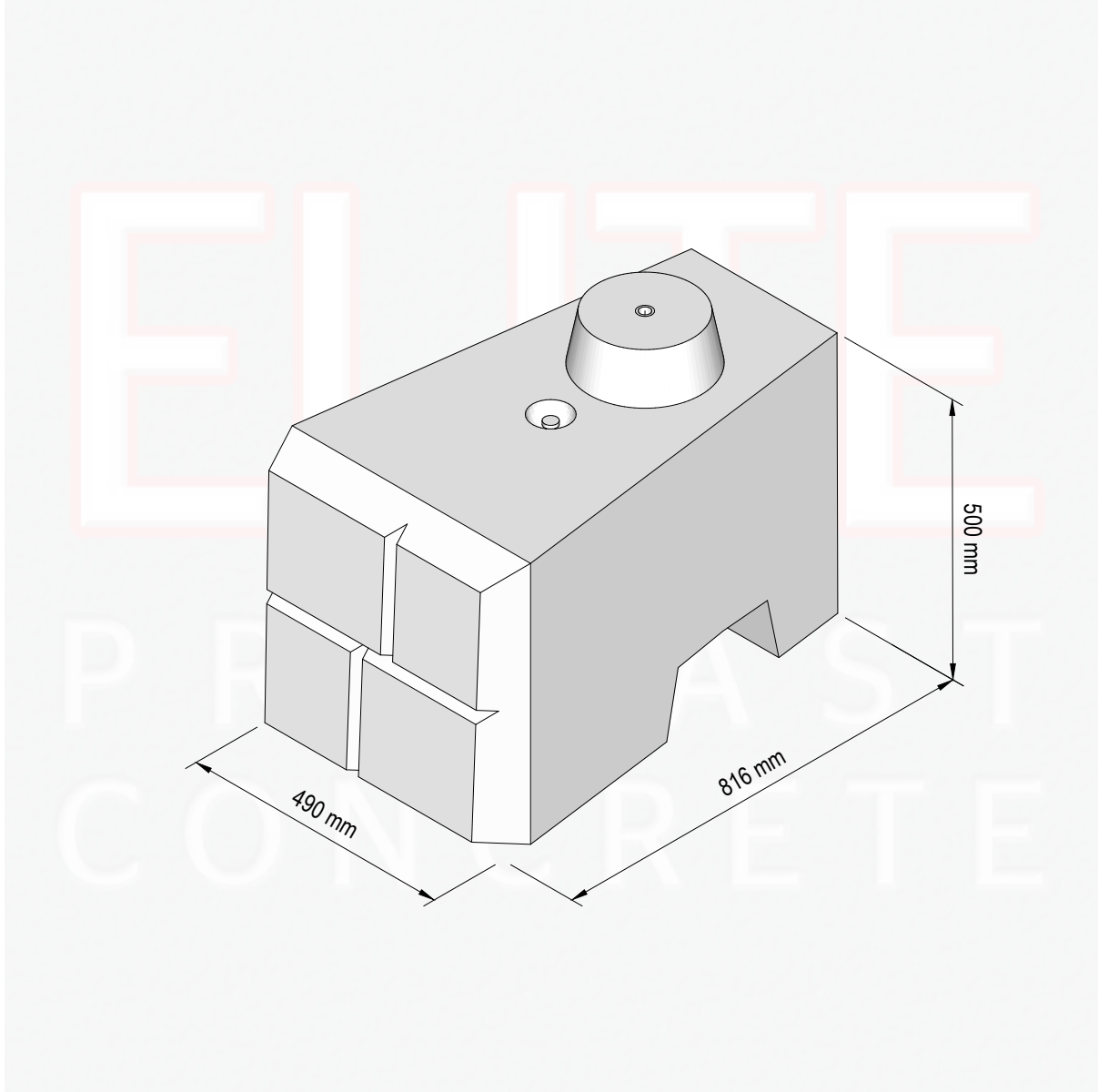

Approx. Weight : 358kg

REV	DATE	REASON FOR ISSUE	DRN	APP	REV	DATE	REASON FOR ISSUE	DRN	APP
					O	05.01.24	For Information.		
								CTC	RMD
TITLE									
					ELITE PRECAST CONCRETE LTD HALESFIELD 9, TELFORD SHROPSHIRE TF7 4QW www.eliteprecast.co.uk				
					DRN CTC CHKD PJC DATE 05-01-24 SIZE A4 SCALE 1:10 DRG EPC-RRC7-C REV O				